

COPYRIGHT © Hangzhou EZVIZ Software Co., Ltd.. ALL RIGHTS RESERVED.

Any and all information, including, among others, wordings, pictures, graphs are the properties of Hangzhou EZVIZ Software Co., Ltd. (hereinafter referred to as “Beans View”). This user manual (hereinafter referred to as “the Manual”) cannot be reproduced, changed, translated, or distributed, partially or wholly, by any means, without the prior written permission of Beans View. Unless otherwise stipulated, Beans View does not make any warranties, guarantees or representations, express or implied, regarding to the Manual.

### **About this Manual**

The Manual includes instructions for using and managing the product. Pictures, charts, images and all other information hereinafter are for description and explanation only. The information contained in the Manual is subject to change, without notice, due to firmware updates or other reasons. Please find the latest version in the Beans View website (<http://www.beansview.com>).

### **Revision Record**

New release – December, 2025

### **Trademarks Acknowledgement**

™, Beans View™ and other Beans View's trademarks and logos are the properties of Beans View in various jurisdictions. Other trademarks and logos mentioned below are the properties of their respective owners.

### **Legal Disclaimer**

TO THE MAXIMUM EXTENT PERMITTED BY APPLICABLE LAW, THE PRODUCT DESCRIBED, WITH ITS HARDWARE, SOFTWARE AND FIRMWARE, IS PROVIDED “AS IS”, WITH ALL FAULTS AND ERRORS, AND Beans View MAKES NO WARRANTIES, EXPRESS OR IMPLIED, INCLUDING WITHOUT LIMITATION, MERCHANTABILITY, SATISFACTORY QUALITY, FITNESS FOR A PARTICULAR PURPOSE, AND NON-INFRINGEMENT OF THIRD PARTY. IN NO EVENT WILL Beans View, ITS DIRECTORS, OFFICERS, EMPLOYEES, OR AGENTS BE LIABLE TO YOU FOR ANY SPECIAL, CONSEQUENTIAL, INCIDENTAL, OR INDIRECT DAMAGES, INCLUDING, AMONG OTHERS, DAMAGES FOR LOSS OF BUSINESS PROFITS, BUSINESS INTERRUPTION, OR LOSS OF DATA OR DOCUMENTATION, IN CONNECTION WITH THE USE OF THIS PRODUCT, EVEN IF Beans View HAS BEEN ADVISED OF THE POSSIBILITY OF SUCH DAMAGES.

TO THE MAXIMUM EXTENT PERMITTED BY APPLICABLE LAW, IN NO EVENT SHALL Beans View'S TOTAL LIABILITY FOR ALL DAMAGES EXCEED THE ORIGINAL PURCHASE PRICE OF THE PRODUCT.

Beans View DOES NOT UNDERTAKE ANY LIABILITY FOR PERSONAL INJURY OR PROPERTY DAMAGE AS THE RESULT OF PRODUCT INTERRUPTION OR SERVICE TERMINATION CAUSED BY: A) IMPROPER INSTALLATION OR USAGE OTHER THAN AS REQUESTED; B) THE PROTECTION OF NATIONAL OR PUBLIC INTERESTS; C) FORCE MAJEURE; D) YOURSELF OR THE THIRD PARTY, INCLUDING WITHOUT LIMITATION, USING ANY THIRD PARTY'S PRODUCTS, SOFTWARE, APPLICATIONS, AND AMONG OTHERS.

REGARDING TO THE PRODUCT WITH INTERNET ACCESS, THE USE OF PRODUCT SHALL BE WHOLLY AT YOUR OWN RISKS. Beans View SHALL NOT TAKE ANY RESPONSIBILITIES FOR ABNORMAL OPERATION, PRIVACY LEAKAGE OR OTHER DAMAGES RESULTING FROM CYBER ATTACK, HACKER ATTACK, VIRUS INSPECTION, OR OTHER INTERNET SECURITY RISKS; HOWEVER, Beans View WILL PROVIDE TIMELY TECHNICAL SUPPORT IF REQUIRED. SURVEILLANCE LAWS AND DATA PROTECTION LAWS VARY BY JURISDICTION. PLEASE CHECK ALL RELEVANT LAWS IN YOUR JURISDICTION BEFORE USING THIS PRODUCT IN ORDER TO ENSURE THAT YOUR USE CONFORMS TO THE APPLICABLE LAW. Beans View SHALL NOT BE LIABLE IN THE EVENT THAT THIS PRODUCT IS USED WITH ILLEGITIMATE PURPOSES.

IN THE EVENT OF ANY CONFLICTS BETWEEN THE ABOVE AND THE APPLICABLE LAW, THE LATTER PREVAILS.

# Table of Contents

<b>Overview</b> .....	<b>1</b>
1. Package Contents .....	1
2. Basics .....	2
<b>Setup</b> .....	<b>3</b>
1. Get the Beans View App .....	3
2. Connect to Power .....	4
3. Add Camera to Beans View .....	4
<b>Installation</b> .....	<b>4</b>
1. Installation Location .....	4
2. Install a microSD Card (Optional) .....	5
3. Install the Mounting Plate .....	5
4. Install the Camera .....	6
<b>View Your Device</b> .....	<b>7</b>
1. Live View .....	7
2. Settings .....	8
<b>FAQ</b> .....	<b>9</b>
<b>Initiatives on the Use of Video Products</b> .....	<b>10</b>
<b>Information For Private Households</b> .....	<b>11</b>

# Overview

## 1. Package Contents



or



Power Cable (x1)

Camera (x1)



Power Adapter (x1)



Screw Kit (x1)



or



\*Drill Template (x1)

\*Mounting Plate (x1)



Regulatory Information (x2)



Quick Start Guide (x1)



- The appearance of the camera and power adapter depends on your actual purchase.
- The appearance of the drill template and mounting plate depends on your selected configuration. This manual uses one combination as an example to illustrate the installation process.

## 2. Basics



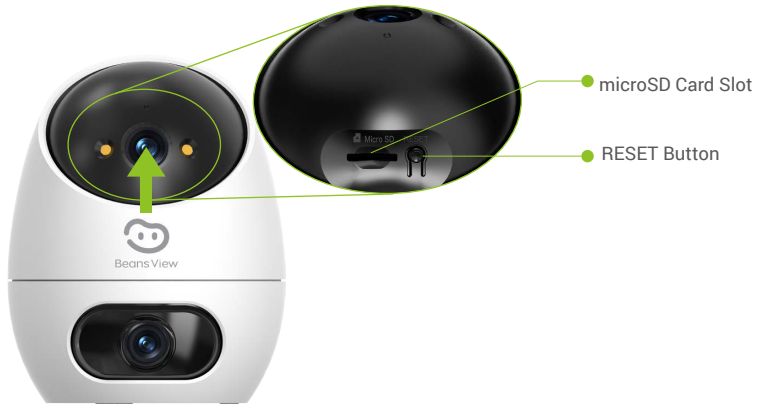



### For Dual 1080p, Dual 2K Camera:



**i** In the following section of this document, we will take the Dual 1080p, Dual 2K version as an example.





Name	Description
LED Indicator	 Solid Red: Camera starting up.
	 Slow-flashing Red: Network exception.
	 Fast-flashing Red: Camera exception (e.g. microSD card error).
	 Solid Blue: Video being viewed in the Beans View app.
	 Fast-flashing Blue: Camera ready for network connection.
	 Slow-flashing Blue: Camera running properly.
microSD Card Slot	<ul style="list-style-type: none"> <li>Initialize the card in the Beans View app before using it.</li> <li>Recommended compatibility: Class 10, maximum space 512GB.</li> </ul>
RESET Button	When the camera is working, press and hold the button for 4 seconds to restart and set all parameters to default.
Call Button	Press the button once to initiate a call, and the Beans View app will receive the call request.

## Setup

### Follow the steps to set your camera:

1. Get the Beans View app, and log in to your Beans View app account.
2. Power on your camera.
3. Add your camera to your Beans View account.

### 1. Get the Beans View App

1. Connect your mobile phone to Wi-Fi (suggested).
2. Download and install the Beans View app by searching "Beans View" in the App Store or Google Play™.
3. Launch the app and register a Beans View user account.

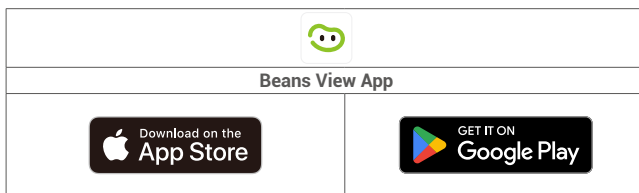

**i** If you have already used the app, please make sure that it is the latest version. To find out if an update is available, go to the app store and search for Beans View.

## 2. Connect to Power

Plug the power cable into the camera, and then plug the power adapter into an outlet as shown in the figure below.



- It is recommended to use the power cable and power adapter included in the package.
- For disconnection from power supply, unplug the power connector from the device.

## 3. Add Camera to Beans View

1. When the LED indicator flashes blue quickly, it indicates that the camera is ready for Wi-Fi configuration.
2. Log in to your account using the Beans View app.
3. On the Home screen, tap “+” in the upper-right corner to go to the Scan QR Code page.
4. Scan the QR code on the Quick Start Guide cover or on the body of the camera.



5. Follow the Beans View app wizard to finish Wi-Fi configuration and add the camera to your Beans View account.

- If you want to change your camera's Wi-Fi, press and hold the RESET button for 4 seconds and repeat the steps above.

## Installation

### 1. Installation Location

Choose a location with a clear, unblocked field of view and with a good wireless signal to the camera. Please keep the following tips in mind:

- Remove the protective film from the lens.
- Make sure the wall is strong enough to withstand three times the weight of the camera.
- It is recommended to set detection sensitivity on Beans View app when selecting location. Thus you can verify if motion can be detected in the camera's placement and adjust the sensitivity based on the size and distance of detected object.

## 2. Install a microSD Card (Optional)

1. Rotate the sphere upwards until you see the card slot.
2. Insert a microSD card (purchase separately) into the card slot as shown in the figure below.



3. In the Beans View app, tap Record List in the Device Settings page to check the SD card status.
  4. If the memory card status displays as Uninitialized, tap to initialize it.
- i** The status will then change to Normal and it can store videos.

## 3. Install the Mounting Plate

The camera can be placed horizontally or mounted on the ceiling. Here we take ceiling mounting as an example.

- i**
- Make sure the ceiling is strong enough to withstand three times the weight of the camera.
  - Avoid installing the camera in an area that gets a lot of light shining directly into the camera lens.
1. Place the drill template onto the surface you have chosen to mount the camera.
  2. (For cement ceiling/wall only) Drill screw holes according to the template, and insert anchors.
  3. Use metal screws to fix the mounting plate.

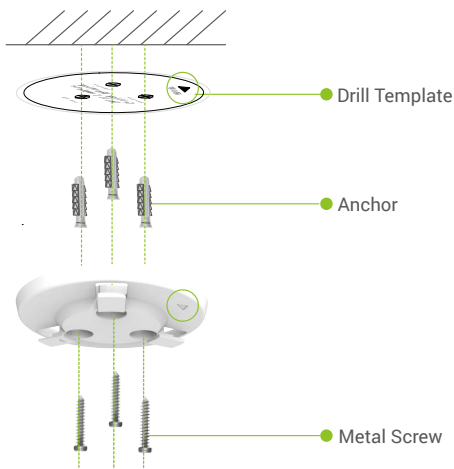

#### 4. Install the Camera

Mount the camera to the mounting plate, and turn it clockwise until it is fixed.



# View Your Device

**i** The app interface may change due to version update. Please refer to the actual page.

## 1. Live View

When you launch the Beans View app, the device page displays as shown below.

You can view and listen to a live feed, take snapshots or recordings, and choose video definition as needed.

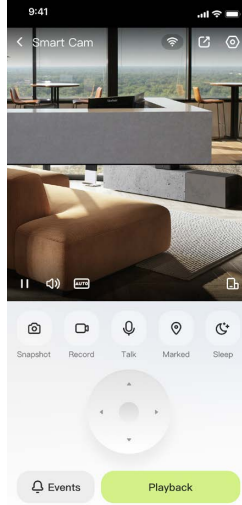

Icon	Description
	Share. Share your device with anyone you want.
	Settings. View or change the device settings.
	Full Screen Display. Tap to enjoy a full screen display for your field of view.
	Snapshot. Take a snapshot.
	Record. Manually start/stop recording.
	PTZ. Rotate the camera to get broader field of view. Preset Location. Control the PTZ to set the monitoring site as preset locations.
	Talk. Tap the icon, and then follow the on-screen instructions to talk to or listen to people in front of the camera.
	Sleep Mode. Tap to enable sleep mode, the video will stop displaying and the alarm notification will be turned off.
	Definition. Tap to select a video resolution.
	Marked. Tap to mark the position displayed in the current monitoring screen.

## 2. Settings

In the settings page, you can set the parameters of the device.

Parameter	Description
Name	Customize the name of your device.
Armed/Disarmed	<ul style="list-style-type: none"><li>• Armed: When an event occurs, it will be recorded in the app message event.</li><li>• Disarmed: When an event occurs, it will not be recorded in the app message event.</li></ul>
Intelligent Detection	You can select between different detection types for your device.
Message Notification	You can manage the device message and Beans View app notification.
PTZ Settings	You can set parameters of PTZ for your device, like PTZ position calibration and PTZ preset here.
Privacy Settings	You can encrypt your videos with encryption password and set sleep plan here.
Audio Settings	You can set relevant audio parameters for your device.
Image Settings	You can set relevant image parameters for your device.
Light Settings	When disabled, the camera indicator will be off.
Record List	You can see the microSD card capacity, and also you can enable or disable cloud storage service here.

### General Settings

Network Settings	You can see the connection status.
Device Information	You can see the device information here.
Share Device	You can share the device to your family members or guests.

### Intelligent Service

CloudPlay	<p>You can subscribe and manage the cloud storage.</p> <ul style="list-style-type: none"><li>•  The function is only available in certain countries. Please verify the availability in your country before purchasing.</li><li>• The producer reserves the right of final explanation.</li></ul>
Restart Device	Tap to restart the device.
Delete Device	Tap to delete the device from Beans View app.

# FAQ

**Q: If the camera is offline, will the video recording continue?**

A: If the camera is powered on but disconnect to the Internet, then video recording on microSD card will continue but cloud recording will stop. If the camera is powered off, both video recordings will stop.

**Q: What if I forget my password?**

A: Please go to the Beans View app > login page, tap on “Forgot password?”> Enter your account’s email address or phone number.(Send)> Input the verification code > Reset your password.

**Q: Why can't I receive my verification code?**

- A:
1. If you registered the account via email, please check your junk mail.  
If you still can't receive the verification code, you might have email filter/block restricting this email, please check with your email provider.
  2. If you registered an account via mobile number, please confirm whether your mobile can receive SMS short codes or not.
  3. If you still haven't received the verification code, please provide your number, your country, time of request to the support center at support@beansview.com or contact your regional support team.

**Q: How to solve Wi-Fi configuration failed?**

- A: Please check the following settings:
1. Ensure that your mobile phone is connected to the Wi-Fi and the Wi-Fi network is working properly.
  2. Check the network condition:
    - Make sure your network has no firewall or other limits.
    - Ensure the router can distribute IP address to your device or disable the static IP setting (DHCP is enabled by default on all Beans View devices).
  3. Reset your camera; ensure that your device is in ready mode or Wi-Fi configuration mode > then use the Beans View app for device Wi-Fi configuration.

**Q: How to get the device verification code (6 capital letters)?**

- A: Please note that for most Beans View devices, usually there are two ways to get the 6 capital letters device verification code:
- For most of the models, you can find it on the device sticker/label of the Beans View device;
  - Alternatively, you can also find the verification code in Device Settings > Device Information > Verification Code.

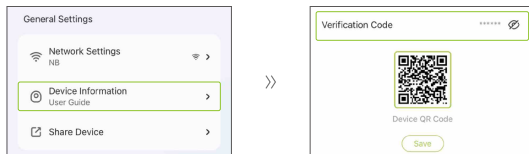

**i** For additional information about the device, please refer to [www.beansview.com](http://www.beansview.com).

# Initiatives on the Use of Video Products

Dear Valued Beans View Users,

Technology affects every aspect of our life. As a forward-looking tech company, we are increasingly aware of the role technology plays in improving efficiency and quality of our life. At the same time, we are also aware of the potential harm of its improper usage. For example, video products can record real, complete and clear images, therefore they hold great values in representing facts. Nevertheless, improper distribution, use and/or processing of video records may infringe on the privacy, legitimate rights and interests of others.

Committed to innovating technology for the good, we at Beans View hereby earnestly advocate that every user shall use video products properly and responsibly, thus to collectively create a positive environment where all related practices and usage comply with applicable laws and regulations, respect individuals' interests and rights, and promote social morality.

Here are Beans View's initiatives that we'd appreciate your attention:

1. Each individual possesses a reasonable expectation of privacy, and the use of video products should not be in conflict with such reasonable expectation. Therefore, a warning notice which clarifies the monitoring range should be displayed in a reasonable and effective manner, when installing video products in public areas. For non-public areas, the rights and interests of people involved shall be evaluated thoughtfully, including but not limited to, installing video products only after obtaining the consent of the stakeholders, and not installing highly-invisible video products without other's knowledge.
2. Video products objectively records footage of real activities within specific time and space. Users shall reasonably identify the people and rights involved in this scope in advance, to avoid any infringement of portrait, privacy or other legal rights of others while protecting themselves through video products. Notably, if you choose to enable the audio recording function on your camera, it will capture sounds, including conversations, within the monitoring range. We highly recommend a comprehensive assessment on the potential sound sources in the monitoring range, so as to fully understand the necessity and the reasonableness before you turn on the audio recording function.
3. Video products in use will consistently generate audio or visual data from real scenes –possibly including biometric information such as facial images – based on the user's selection of product features. Such data can be used or processed to use. Video products are only technological tools that do not and cannot humanly practice legal and moral standards to guide lawful and proper use of data. It is the methods and purposes of the people who control and use the generated data that make a difference. Therefore, data controllers shall not only strictly abide by applicable laws and regulations, but also fully respect non-obligatory rules including international conventions, moral standards, cultural norms, public order and local customs. Furthermore, we should always prioritize the protection of privacy and portrait rights, and other reasonable interests.
4. The video data continuously generated by video products carries the rights, values and other demands of various stakeholders. Thus, it is extremely crucial to ensure data security and shield the products from malicious intrusions. Every user and data controller shall, undertake all reasonable and necessary measures to maximize product and data security, avoiding data leakage, improper disclosure or misuse, including but not limited to, setting up access control, selecting a suitable network environment where video products are connected, establishing and constantly optimizing network security.
5. Video products have made great contributions to enhance the safety of our society, and we believe that they will continue to play a positive role in various aspects of our daily life. Any attempt to abuse these products to violate human rights or engage in unlawful activities contradicts the very essence of the value in tech innovation and product development. We encourage every user to establish your own methods and rules to evaluate and monitor the use of video products, so as to ensure that these products are always used properly, thoughtfully and with goodwill.

## Information For Private Households

1. Separate collection of waste equipment: Electrical and electronic equipment that has become waste is referred to as waste equipment. Owners of waste equipment must dispose of it separately from unsorted municipal waste. In particular, waste equipment does not belong in household waste, but in special collection and return systems.
2. Batteries and rechargeable batteries as well as lamps: Owners of waste equipment shall, as a rule, separate waste batteries and rechargeable batteries that are not enclosed in the waste equipment, which can be removed from the waste equipment without being destroyed, from the waste equipment before handing them in at a collection point. This does not apply if waste equipment is prepared for reuse with the participation of a public waste management authority.
3. Options for returning waste equipment: Owners of waste equipment from private households can return it free of charge to the collection points of the public waste management authorities or to the take-back points set up by manufacturers or distributors within the meaning of the Electrical and Electronics Equipment Law. Stores with a sales area of at least 400 m<sup>2</sup> for electrical and electronic equipment and those grocery stores with a total sales area of at least 800 m<sup>2</sup> that offer electrical and electronic equipment several times a year or on a permanent basis and make it available in the market are required to take it back. This also applies in the case of distribution using means of distance communication, if the storage and shipping areas for electrical and electronic equipment are at least 400 m<sup>2</sup> or the total storage and shipping areas are at least 800 m<sup>2</sup>. Distributors shall, in principle, ensure take-back by providing suitable return facilities at a reasonable distance from the respective end user. The possibility of returning waste equipment free of charge exists for distributors who are obliged to take it back, among other things, if a new similar device that essentially fulfills the same functions is delivered to an end user.
4. Privacy Notice: Waste equipment often contains sensitive personal data. This applies in particular to devices of information and telecommunications technology such as computers and smartphones. In your own interest, please note that each end user is responsible for deleting the data on the waste equipment to be disposed of.
5. Meaning of the symbol “crossed-out wheelee bin”: The symbol of a crossed-out wheelee bin regularly depicted on electrical and electronic equipment indicates that the respective device is to be collected separately from unsorted municipal waste at the end of its service life.